



## Verilog / SystemVerilog

- **History & main concepts – structure, description styles, data types**
- **Procedural & assignment; if-then, case & loop statements**
- **Functional hierarchy – tasks & functions**
- **Time & events; parallelism; fork, join & disable statements**
- **Structural & behavioral descriptions**
  
- **Michael John Sebastian Smith, “Application-Specific Integrated Circuits.” Addison-Wesley – <http://www10.edacafe.com/book/ASIC/ASICs.php> [see ch. 11]**
- **Stuart Sutherland, Simon Davidmann, Peter Flake and Phil Moorby. “SystemVerilog for Design: A Guide to Using SystemVerilog for Hardware Design and Modeling.” Springer.**
- **Ken Coffman, “Real world FPGA design with Verilog.” Prentice Hall.**
- **Donald E. Thomas, Philip R. Moorby, “The Verilog® Hardware Description Language.” Kluwer Academic Publishers.**
- **James M. Lee, “Verilog Quickstart: a practical guide to simulation and synthesis in Verilog.” Kluwer Academic Publishers.**
- **<http://systemverilog.in/>**
- **<http://www.project-veripage.com/>**
- **<http://www.angelfire.com/in/verilogfaq/>**



# History

- Invented as a simulation language
- 1983/85 – Automated Integrated Design Systems (later as Gateway Design Automation)
- 1989/90 – acquired by Cadence Design Systems
- 1990/91 – opened to the public in 1990 - OVI (Open Verilog International) was born
- 1992 – the first simulator by another company
- 1993 – IEEE working group (under the Design Automation Sub-Committee) to produce the IEEE Verilog standard 1364
- May 1995 – IEEE Standard 1364-1995
- 2001 – IEEE Standard 1364-2001 – revised version
- 2005 – IEEE Standard 1364-2005 – clarifications; Verilog-AMS
- 2005 – IEEE Standard 1364-2001 – SystemVerilog
- 2009 – Verilog and SystemVerilog merged – IEEE Standard 1800-2009
- 2013 – IEEE Standard 1800-2012 – SystemVerilog 2012
- development continues...



## SystemVerilog extras

- **New data types - int, shortint, longint, byte, bit, logic, enum, typedef, struct**
- **C-like parameters for modules**
- **New processes - always\_comb, always\_latch, always\_ff**
- **Packages, additional operators, assertions, interfaces**

## SystemVerilog presentations

- **Narges Baniyadi (2004)**
  - [http://www.powershow.com/view1/29796d-ZDc1Z/System\\_Verilog\\_powerpoint\\_ppt\\_presentation](http://www.powershow.com/view1/29796d-ZDc1Z/System_Verilog_powerpoint_ppt_presentation)
- **Doulos Ltd - A User's Experience with SystemVerilog (2004)**
  - [https://www.doulos.com/knowhow/sysverilog/snug04europe/snug04\\_bromley\\_smith\\_slides.pdf](https://www.doulos.com/knowhow/sysverilog/snug04europe/snug04_bromley_smith_slides.pdf)
- **Manmohan Singh (2007)**
  - [http://www.powershow.com/view1/d3b73-ZDc1Z/An\\_Introduction\\_to\\_SystemVerilog\\_powerpoint\\_ppt\\_presentation](http://www.powershow.com/view1/d3b73-ZDc1Z/An_Introduction_to_SystemVerilog_powerpoint_ppt_presentation)
- **System Verilog Tutorial (2015)**
  - <http://www.slideshare.net/phagwarae2matrix/system-verilog-tutorial-vhdl>
- **SystemVerilog 3.1a LRM (2015)**
  - <http://www.slideshare.net/jainatush/system-verilog-44103589>



# Hello, world!

```
module world;  
  
    initial  
        begin  
            $display ( "Hello, world!" );  
        end  
  
endmodule
```

- **ModelSim**

```
run -all  
# Hello, world!
```



## Main concepts

- **Modules**
  - modules
  - functions & tasks
- **Case sensitive**
  - lower case keywords
  - **identifier - a sequence of letters, digits, dollar sign (\$), and underscore (\_)**  
`identifier ::= simple_identifier | escaped_identifier`  
`simple_identifier ::= [a-zA-Z][a-zA-Z_0-9$]*`  
`escaped_identifier ::= \{any_ASCII_character_except_white_space} white_space`
- **No delta-delay**
  - non-deterministic parallelism



# Module

```
module name ( input_output_list );  
    module_body  
endmodule
```

Ports:

**wire** - by default (can be skipped)

**reg** ~ keeps content

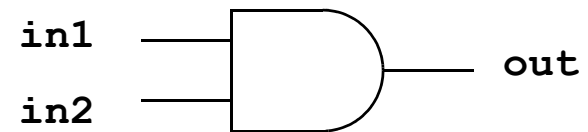

```
// structural  
module AND2 (in1, in2, out);  
    input in1;  
    input in2;  
    output out;  
    wire in1, in2, out;  
    and u1 (out, in1, in2);  
endmodule
```



```
// behavioral
module AND2 (in1, in2, out);
    input in1;
    input in2;
    output out;
    wire in1, in2;
    reg out;
    always @( in1 or in2 )
        out = in1 & in2;
endmodule
```

```
// data flow
module AND2 (in1, in2, out);
    input in1;
    input in2;
    output out;
    wire in1, in2, out;
    assign out = in1 & in2;
endmodule
```



```
module test_and2;
    reg i1, i2;    wire o;

    AND2 u2 (i1, i2, o);

    initial begin
        i1 = 0; i2 = 0;
        #1 $display("i1 = %b, i2 = %b, o = %b", i1, i2, o);
        i1 = 0; i2 = 1;
        #1 $display("i1 = %b, i2 = %b, o = %b", i1, i2, o);
        i1 = 1; i2 = 0;
        #1 $display("i1 = %b, i2 = %b, o = %b", i1, i2, o);
        i1 = 1; i2 = 1;
        #1 $display("i1 = %b, i2 = %b, o = %b", i1, i2, o);
    end
endmodule
```

- **always**
- **initial**
- **begin ... end**

```
i1 = 0, i2 = 0, o = 0
i1 = 0, i2 = 1, o = 0
i1 = 1, i2 = 0, o = 0
i1 = 1, i2 = 1, o = 1
```

**Results...**





## Example AND-OR

```
module and_or (in1, in2, in3, in4, out);  
    input in1, in2, in3, in4;  
    output out;  
    wire tmp;  
    and #10 u1 (tmp, in1, in2),  
              u2 (undec, in3, in4);  
    or #20 (out, tmp, undec);  
endmodule
```

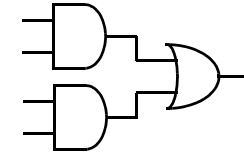

```
module and_or (in1, in2, in3, in4, out);  
    input in1, in2, in3, in4;  
    output out;  
    wire tmp;  
    assign #10 tmp = in1 & in2;  
    wire #10 tmp1 = in3 & in4;  
    assign #20 out = tmp | tmp1;  
    // assign #30 out = (in1 & in2) | (in3 & in4);  
endmodule
```



```
module and_or (in1, in2, in3, in4, out);
    input in1, in2, in3, in4;
    output out;
    reg out;
    always @(in1 or in2 or in3 or in4) begin
        if (in1 & in2) out = #30 1;
        else out = #30 (in3 & in4);
    end
endmodule

module test_and_or;
    reg r1, r2, r3, r4;
    wire o;
    and_or u2 (.in2(r2), .in1(r1), .in3(r3), .in4(r4), .out(o));
    initial begin : b1
        reg [4:0] i1234;
        for ( i1234=0; i1234<16; i1234=i1234+1 ) begin
            { r1, r2, r3, r4 } = i1234[3:0];
            #50 $display("r1r2r3r4=%b%b%b%b, o=%b", r1, r2, r3, r4, o);
        end
    end
endmodule
```



# Data types

- **Constants - decimal, hexadecimal, octal & binary**

- **Format** `<width>'<radix><value>`
  - `<width>` - optional, in bits, decimal constant
  - `<radix>` - optional, base, can be one of b, B, d, D, o, O, h or H
  - `<value>` - a sequence of symbols depending on the radix:
    - binary - 0, 1, x, X, z & Z
    - octal - also 2, 3, 4, 5, 6 & 7
    - hexadecimal - also 8, 9, a, A, b, B, c, C, d, D, e, E, f & F
    - decimal - 0 to 9, but not x or z

```
15          (decimal 15)
'h15        (decimal 21, hex 15)
5'b10011    (decimal 19, binary 10011)
12'h01F     (decimal 31, hex 01F)
'b01x       (no decimal value, binary 01x)
```

- **String constants, e.g. "my-string"**
  - are converted to their ASCII equivalent binary format, e.g. "ab" == 16'h5758
- **Real constants - ordinary scientific notation**
  - e.g. 22.73 , 12.8e12



- **Physical data types**

- **binary nets - wire, wand, wor, etc., and**
  - continuously driven
- **registers - reg**
  - “remembers” the last assignment

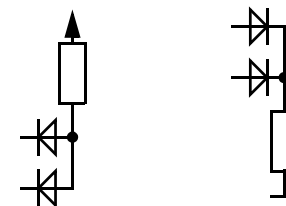

- **Registers can be assigned only inside behavioral instances**
- **Nets are driven all the time and cannot be assigned in behavioral block**
- **Register can be interpreted as a storage element (latch, flip-flop) but not necessarily**
- **Nets & registers are interpreted as unsigned integers**

- **Abstract data types**

- **integer** - almost as a 32-bit reg but signed
- **time** - 64-bit unsigned integer
- **real** - floating point, platform depending
- **event** - a special variable without value, used for synchronization
- **parameter** - “named constant”, set before simulation starts



## Declarations

- **Width in bits - physical variables only**
- **Arrays - only types *integer*, *real* and *reg***

```
integer i, j;
real f, d;
wire [7:0] bus;           // 1x8 bits
reg [0:15] word;         // 1x16 bits
reg arr[0:15];           // 16x1 bits
reg [7:0] mem[0:127];    // 128x8 bits
event trigger, clock_high;
time t_setup, t_hold;
parameter width=8;
parameter width2=width*2;
wire [width-1:0] ww;
// The following are illegal
wire w[0:15];            // No arrays
wire [3:0] a, [7:0] b;   // Only one width per decl.
```



# Operations

+ - * / %	(arithmetic)
> >= < <=	(relational)
! &&	(logical)
== !=	(logical equality)
?:	(conditional)
{}	(concatenate)
=== !==	(case equality)
~ ^ ^~ &	(bit-wise)
<< >>	(shift)

+ - ! ~	(highest)
* / %	
+ -	(binary op.)
<< >>	
< <= > >=	
= == !=	
=== !==	
& ~&	
^ ^~	
~	
&&	
?:	(lowest)



## Bit-wise as unary operations

```
^word === 1'bx  
&word === 0
```

## Comparisons

```
'bx == 'bx    ≡ x  
'bx === 'bx   ≡ 1
```

## Concatenation

```
{2'b1x, 4'h7} === 6'b1x0111  
{cout, sum} = in1 + in2 + cin;  
{sreg, out} = {in, reg};  
{3{2'b01}} === 6'b010101
```

## Indexing

```
reg [15:0] array [0:10];  
reg [15:0] temp;  
    ...  
temp = array[3];  
... temp[7:5] ...  
// array[3][7:5] is illegal
```



## Procedural and assignment statements

- Procedural statements

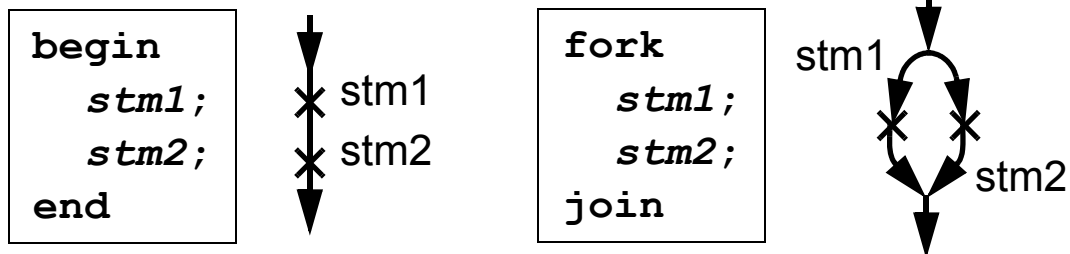

- Assignments

```
lhs-expression = expression;
lhs-expression = #delay expression;
lhs-expression = @event expression;
```

Blocking

```
lhs-expression <= expression;
lhs-expression <= #delay expression;
lhs-expression <= @event expression;
```

Non-blocking





## Conditional Statements

```
if ( bool-expr )  
    statement  
else  
    statement
```

```
case ( expr )  
expr [, expr]* : statement  
default: statement  
endcase
```

- **Case**
  - bit by bit comparison (like `===`)
  - `casez` - 'z' is interpreted as don't care
  - `casex` - 'z' & 'x' are interpreted as don't care



## Loop statements

```
module for_loop;
  integer i;
  initial
    for (i=0;i<4;i=i+1) begin
      ...
    end
endmodule
```

```
module while_loop;
  integer i;
  initial begin
    i=0;
    while (i<4) begin
      ...
      i=i+1;
    end
  end
endmodule
```

```
module repeat_loop(clock);
  input clock;
  initial begin
    repeat (5)
      @(posedge clock);
      $stop;
  end
endmodule
```

```
module forever_loop(a,b,c);
  input a, b, c;
  initial forever begin
    @(a or b or c)
      if ( a+b == c ) $stop;
  end
endmodule
```



## Functional hierarchy

- **Tasks**

```
task tsk;  
  input i1, i2;  
  output o1, o2;  
  $display("Task tsk, i1=%0b, i2=%0b",i1,i2);  
  #1 o1 = i1 & i2;  
  #1 o2 = i1 | i2;  
endtask
```

- **Access:** `tsk(a,b,c,d);`
- **A task may have timing control construct**



- **Functions**

```
function [7:0] func;  
  input i1;  
  integer i1;  
  reg [7:0] rg;  
  begin  
    rg=i1+2;  
    func=rg;  
  end  
endfunction
```

- **Access:** `x = func(n);`
- **A function may not have timing control construct – executed in zero simulation time**



# Time and events

## Zero-delay simulation model

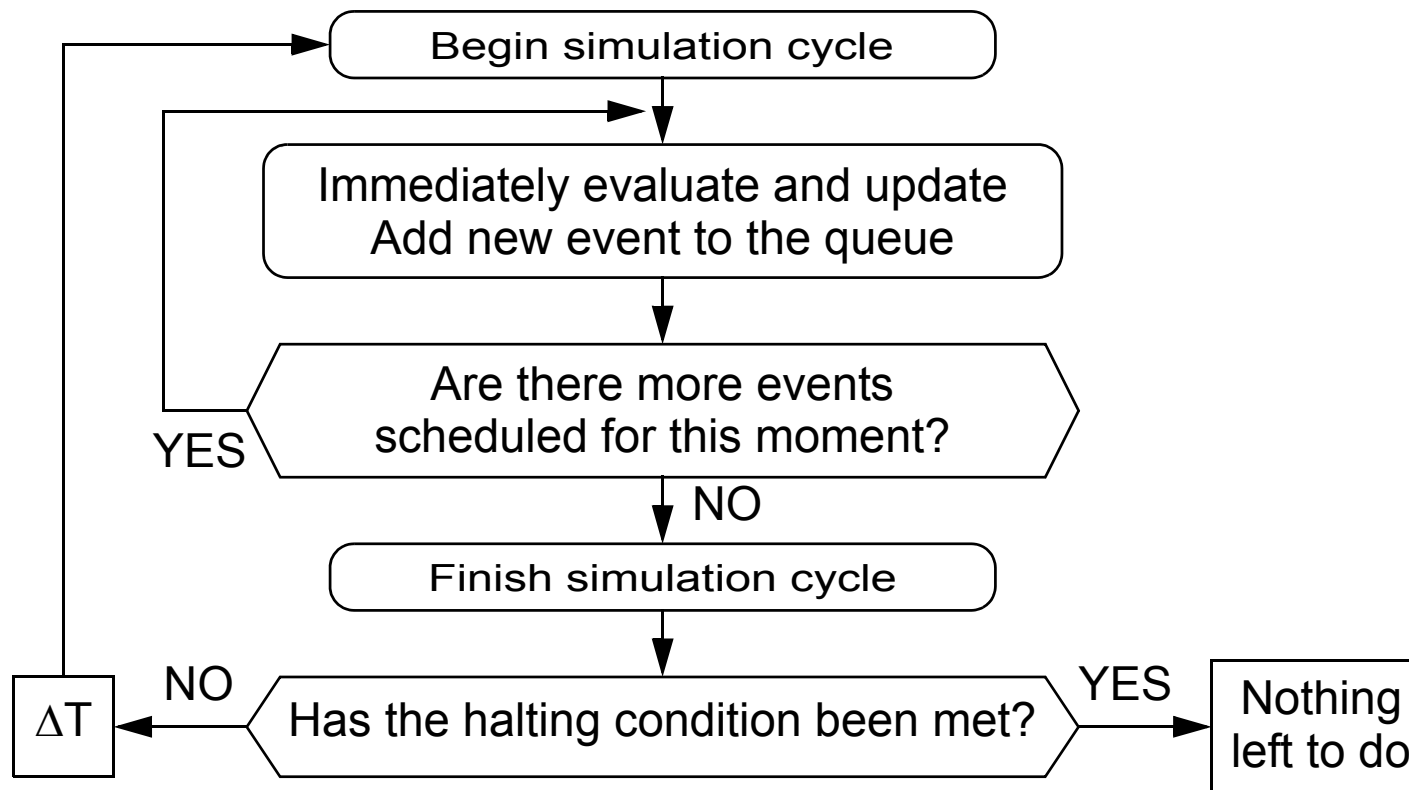



# Zero-delay simulation model (example #1)

```

assign x1 = a & b;
assign x2 = ! c;
assign y = x1 ^ x2;

```

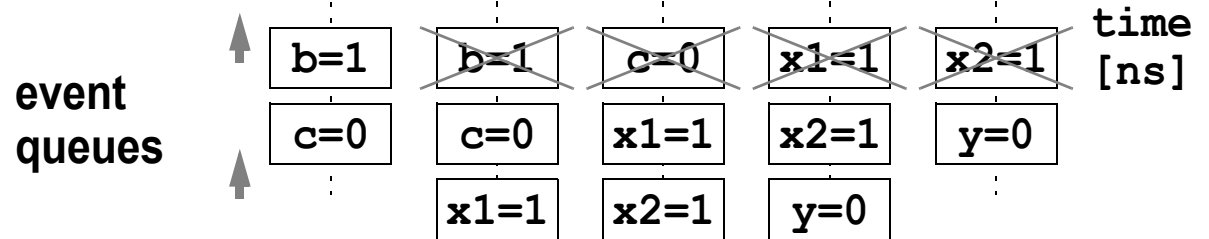
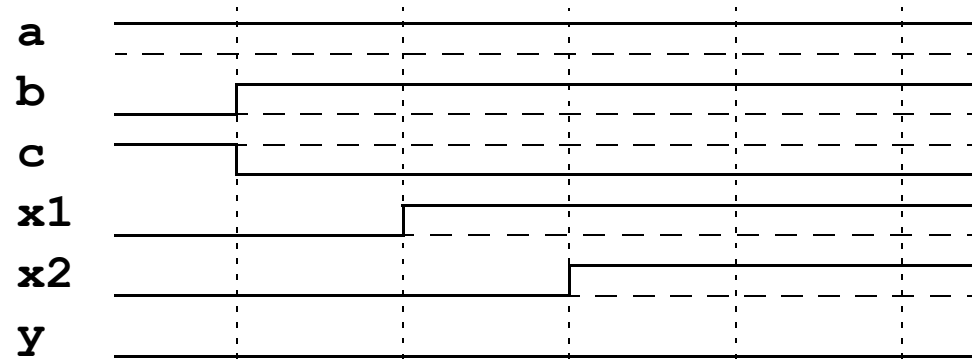
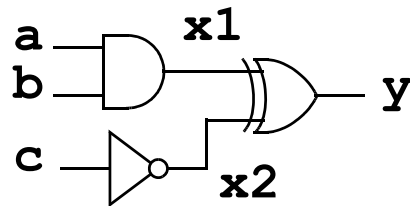



# Zero-delay simulation model (example #2)

```

assign x1 = a & b;
assign x2 = ! c;
assign y = x1 ^ x2;

```

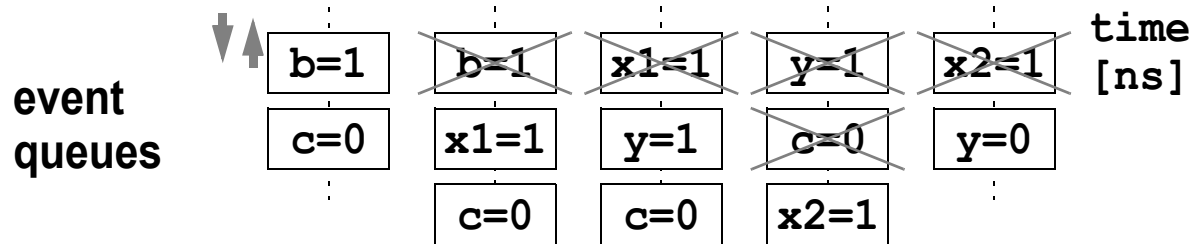
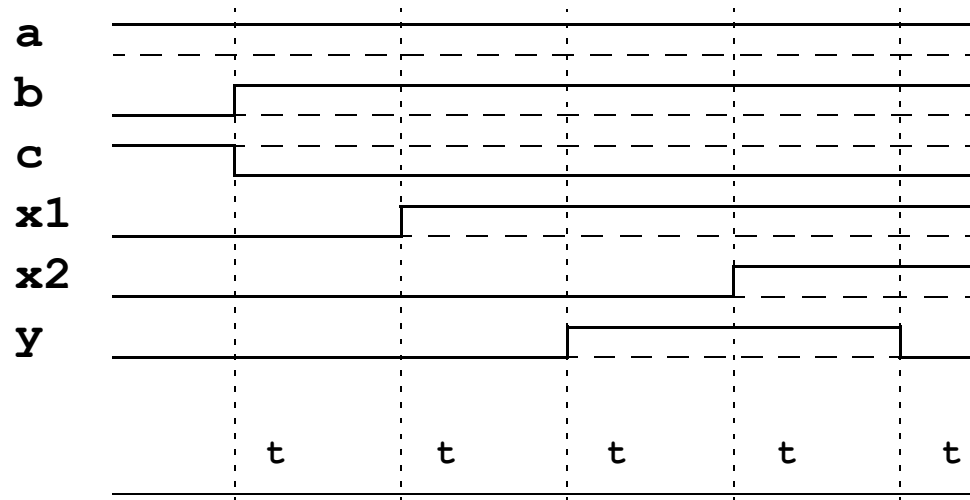
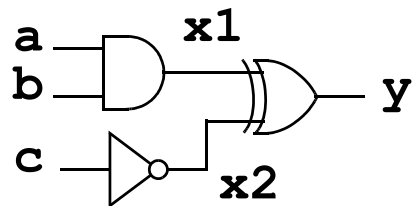



## Non-deterministic behavior

```
module stupidVerilogTricks (f,a,b);  
  input  a, b;  
  output f;  
  reg    f, q;  
  
  initial    f = 0;  
  
  always @(posedge a)    #10 q = b;  
  
  not ( qBar, q );  
  
  always @q    f = qBar;  
  
endmodule
```

```
q=0  
f=qBar=b=1  
a=0
```

```
a=1  
#10 q=1    [b==1]
```

```
f==?
```

```
1) qBar=0    [q==1]  
   f=0
```

```
2) f=1      [qBar==1]  
   qBar=0   [q==1]
```





## Timing control

- Suspending execution for a fixed time period
- Suspending execution until an event occurs
- Suspending execution until an expression comes true
  - level sensitive event control

```
#expression  
@event-expression  
wait ( expression )
```

```
variable [ or variable ... ]  
posedge one-bit-variable  
negedge one-bit-variable  
event-variable
```

```
@(posedge clk) #5 out=in;
```



## Event Control

```
module event_control;
  event e1, e2;
  initial @e1 begin
    $display("I am in the middle.");
    ->e2;
  end
  initial @e2
    $display("I am the last one...");
  initial begin
    $display("I am the first!");
    ->e1;
  end
endmodule
```

```
I am the first!
I am in the middle.
I am the last one...
```



## Timing control inside assignments

```
state = #clk_period next_state;
```

≡

```
temp = next_state;
#clk_period state = temp;
```

```
state = @my_event next_state;
```

≡

```
temp = next_state;
@my_event state = temp;
```

```
always @(s1) #1 wb1 = s1;
always @(s1) wb1d = #1 s1;
always @(s1) #3 wb3 = s1;
always @(s1) wb3d = #3 s1;
```

```
always @(s1) #1 wn1 <= s1;
always @(s1) wn1d <= #1 s1;
always @(s1) #3 wn3 <= s1;
always @(s1) wn3d <= #3 s1;
```

s1	0000	0001	0010	0011	0100	0101	0110	0111
wb1	0000	0001	0010	0011	0100	0101	0110	0111
wb1d	0000	0001	0010	0011	0100	0101	0110	0111
wb3		0001		0011		0101		0111
wb3d		0000		0010		0100		0110
wn1	0000	0001	0010	0011	0100	0101	0110	0111
wn1d	0000	0001	0010	0011	0100	0101	0110	0111
wn3		0001		0011		0101		0111
wn3d		0000	0001	0010	0011	0100	0101	0110

# Parallelism

- **Structural parallelism**

- modules
- continuous assignments (data-flow style)
- behavioral instances (always & initial blocks)

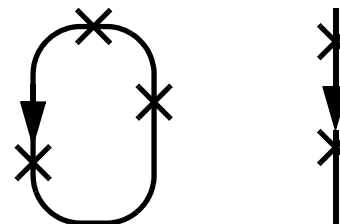

- **Behavioral parallelism**

- fork & join
- disable

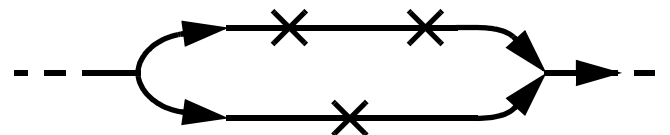



## fork & join

```
module fork_join;
  event a, b;
  initial begin
    // ...
    fork
      @a ;
      @b ;
    join
      // ...
  end
endmodule
```

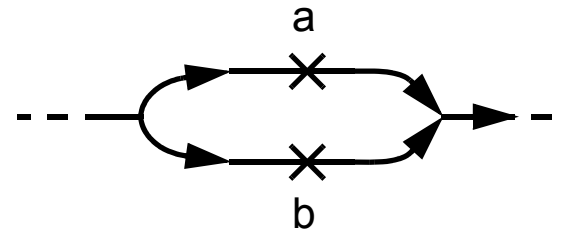

- continues when both events, *a* and *b*, occur

## fork & join + disable

```

module fork_join;
  event a, b; // Block name!
  initial begin
    // ...
    fork : block1
      @a disable block1;
      @b disable block1;
    join
    // ...
  end
endmodule

```

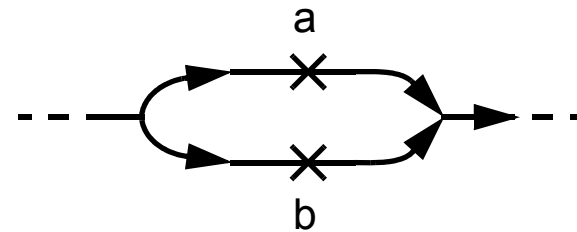

- continues when either *a* or *b* occurs



## disable

```
begin : break
  for (i=0;i<1000;i=i+1) begin : continue
    if (a[i]==0) disable continue; // i.e. continue
    if (b[i]==a[i]) disable break; // i.e. break
    $display("a[" , i , "]=" , a[i]);
  end
end
```

- **disable <block\_name>**
  - removes the rest of events associated with the block
  - named blocks and tasks only
- **named blocks**
  - local variables allowed



## Structural and behavioral descriptions

- Structural – created from lower level modules
- Data-flow – combinational logic – keyword `assign`
- Behavioral – algorithms etc. – keywords `initial` & `always`

```
initial begin
  forever
    @(in1 or in2) begin
      sum = in1 + in2;
      if (sum == 0) zero = 1;
      else          zero = 0;
    end
end
```

≡

```
always
  @(in1 or in2) begin
    sum = in1 + in2;
    if (sum == 0) zero = 1;
    else          zero = 0;
  end
```

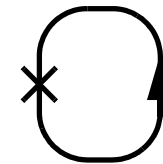
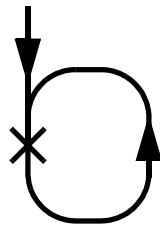





## Behavioral (cont.)

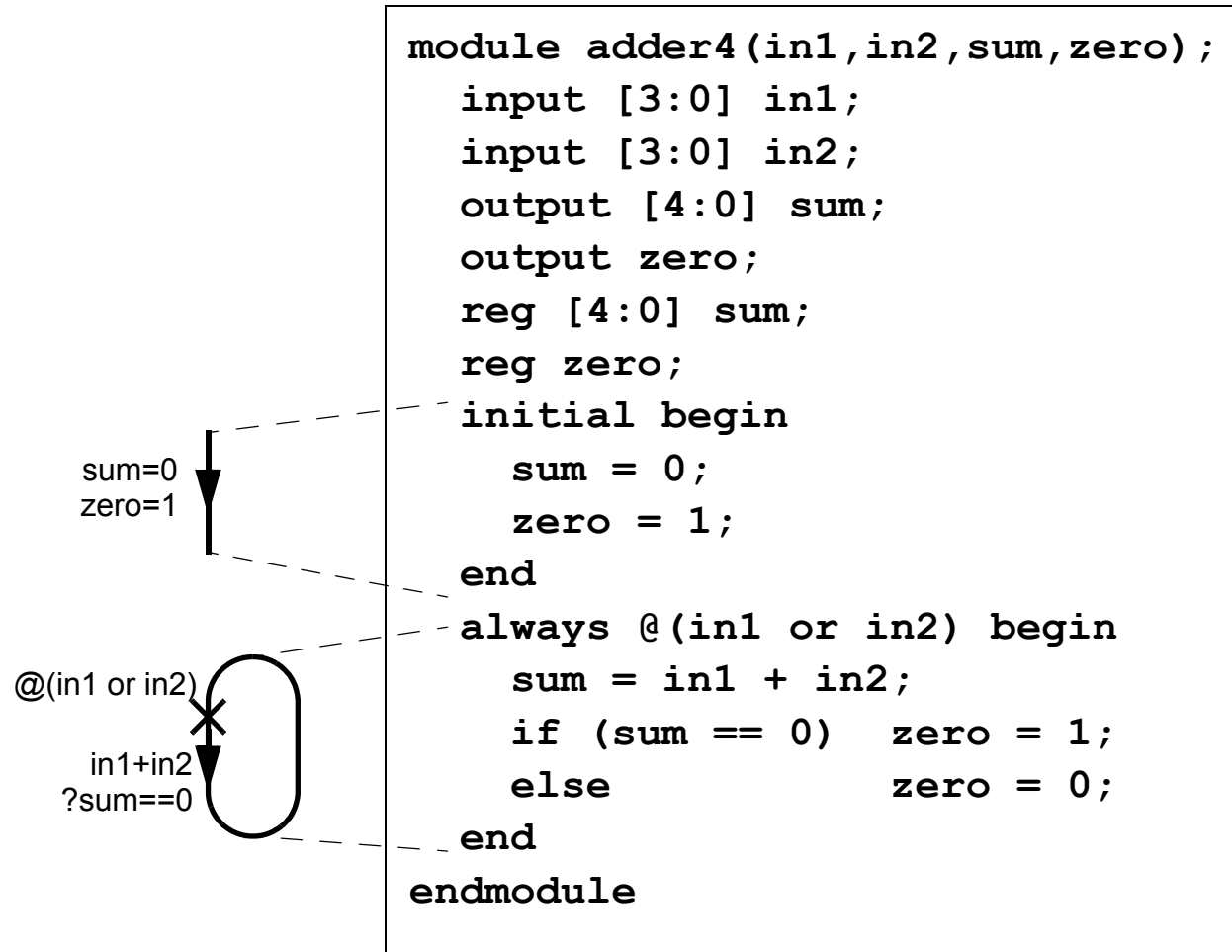



## Behavioral (cont.)

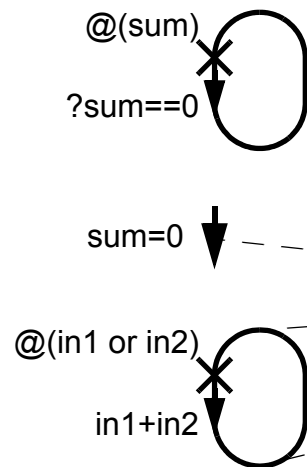

```
module adder4(in1,in2,sum,zero);  
  input [3:0] in1;  
  input [3:0] in2;  
  output [4:0] sum;  
  output zero;  
  reg [4:0] sum;  
  assign zero = (sum==0) ? 1 : 0;  
  initial sum = 0;  
  always @(in1 or in2)  
    sum = in1 + in2;  
endmodule
```



# Structural

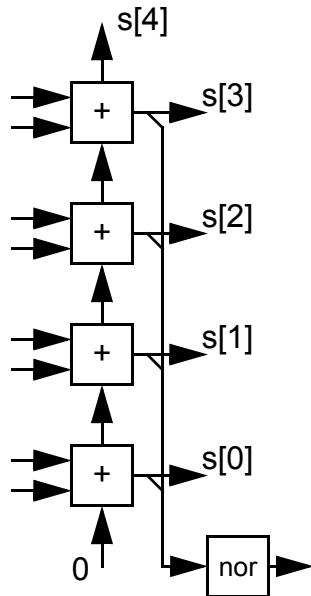

```
module adder4 (in1, in2, s, zero);  
  input [3:0] in1;  
  input [3:0] in2;  
  output [4:0] s;  
  output zero;  
  fulladd u1 (in1[0],in2[0], 0, s[0],c0);  
  fulladd u2 (in1[1],in2[1],c0, s[1],c1);  
  fulladd u3 (in1[2],in2[2],c1, s[2],c2);  
  fulladd u4 (in1[3],in2[3],c2, s[3],s[4]);  
  nor u5 (zero,s[0],s[1],s[2],s[3],s[4]);  
endmodule
```

```
module fulladd (in1, in2, cin, sum, cout);  
  input in1, in2, cin;  
  output sum, cout;  
  assign { cout, sum } = in1 + in2 + cin;  
endmodule
```



## Combined – mixed mode

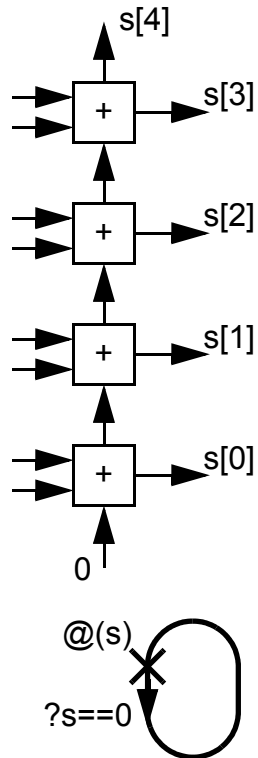

```

module adder4 (in1, in2, s, zero);
  input [3:0] in1;
  input [3:0] in2;
  output [4:0] s;
  output zero;  reg zero;
  fulladd u1 (in1[0],in2[0], 0, s[0],c0);
  fulladd u2 (in1[1],in2[1],c0, s[1],c1);
  fulladd u3 (in1[2],in2[2],c1, s[2],c2);
  fulladd u4 (in1[3],in2[3],c2, s[3],s[4]);
  always @(s)
    if (s == 0)  zero = 1;
    else        zero = 0;
endmodule
  
```



## Advanced topics – parameterized modules

```
module xorx (xout, xin1, xin2);  
    parameter width = 4,  
               delay = 10;  
    output [1:width] xout;  
    input  [1:width] xin1, xin2;  
  
    assign #(delay) xout = xin1 ^ xin2;  
endmodule
```

```
// 8 bits, delay 10  
xorx #(8) (vout,vin1,  
          {b0,b1,b2,b3,b4,b5,b6,b7});
```

```
// 4 bits, delay 20  
xorx #(4,20) (vout,vin1,  
             {b0,b1,b2,b3});
```



## Advanced topics – compiler control

- `'define <macro_label> <replacement>`
- `'ifdef <macro_label>`  
  `// code...`  
`'endif`
- `'include "verilog-file"`

```
'include "design.def"
...
#ifdef DEBUG_MODE      /* Debugging ... */
  initial #1 begin
    $display("\n Time:  Address  Data");
  end
  always @(clk) begin
    $display("%t:  %h  %h",
             $time, address, data);
  end
#endif
```



## Advanced topics – compiler control (cont.)

```
parameter WORD_SIZE = 32;
`define WORD [WORD_SIZE-1:0]
// ...

reg `WORD address, data;
// ...
```

```
// <time_unit>/<time_precision>
`timescale 1 ns / 1 ns
```

```
`timescale 10 ns / 0.1 ns
// ...
#7.748; // delay 77.5 ns
```

- ModelSim SE/PE/XE User's Manual
- IEEE Std 1364-1995 compiler directives



## Advanced topics – memory images

- `$readmemb`
- `$readmemh`

```
...  
reg [DSIZE-1:0] MEM [0:MAXWORDS-1];  
...  
$readmemh ("PROG.FILE", MEM);  
...
```

```
@0000 // Hexadecimal address  
// Code _IC_ _RD_ _S1_ _S2_ _IMM_  
00000000 // 0000.0 000.00 00.000 0.0000 .0000.0000.0000 add.f -,0,0  
00000000 // 0000.0 000.00 00.000 0.0000 .0000.0000.0000 add.c.f -,0,0  
2040007f // 0010.0 000.01 00.000 0.0000 .0000.0111.1111 add.t R1,127,127  
20820ffd // 0010.0 000.10 00.001 0.0000 .1111.1111.1101 add.t R2,R1,-3  
60c40000 // 0110.0 000.11 00.010 0.0000 .0000.0000.0000 add.c.t R3,R2,0  
20043000 // 0010.0 000.00 00.010 0.0011 .0000.0000.0000 add.t -,R2,R3
```





## Advanced topics – user primitives

```
primitive MUX_4_2 (Y,D0,D1,D2,D3,S1,S2);
  input D0,D1,D2,D3,S1,S2;
  output Y;
  table // D0 D1 D2 D3 S1 S2 : Y
    0 ? ? ? 0 0 : 0 ;
    1 ? ? ? 0 0 : 1 ;
    ? 0 ? ? 0 1 : 0 ;
    ? 1 ? ? 0 1 : 1 ;
    // ...
    ? ? ? 0 1 1 : 0 ;
    ? ? ? 1 1 1 : 1 ;
  endtable
endprimitive
```



## Advanced topics – user primitives (cont.)

- one bit wide ports
- wire - combinational
- reg - sequential

0	logic 0
1	logic 1
x	unknown
?	either 0, 1 or x (input ports only)
b	either 0 or 1 (input ports only)
-	no change (outputs of sequential primitives)
(xy)	value change x,y=0,1,x,? or b
*	any value change (same as (??))
r	rising edge on input (01)
f	falling edge on input (10)
p	positive edge ((01), (0x) or (x1))
n	negative edge ((10), (1x) or (x0))



## Advanced topics – more about assignments

- **Behavioral assignments**
  - **assign <assignment>**
    - reg type only
  - **deassign <lvalue>**
    - undoes behavioral assignment
  - **force <assignment>**
    - reg & net types
    - stronger than assign
  - **release <lvalue>**
    - reg & net types
    - undoes force statement

```
<continous_assignment> ::=
    assign [<drive_strength>] [<delay2>] <list_of_net_assignments>;
```



## Advanced topics – more about nets

```
<net_declaration> ::=  
    <net_type> [scalared|vectored] [<strength>]  
    [<range>] [<delay>] <variable_list>;
```

```
<net_type> ::= wire | tri | wand | wor | triand | trior |  
    tri0 | tri1 | supply0 | supply1 | trireg
```

- wire, tri - no logic function (only difference is in the name)
- wand, wor, triand, trior - wired logic (wand==triand, wor==trior)
- tri0, tri1 - connections with resistive pull
- supply0, supply1 - connections to a power supply
- trireg - charge storage on a net

scalared - single bits are accessible (default)

vectored - single bits are not accessible

```
<range> ::= [ <msb>:<lsb> ]
```



## Advanced topics – more about nets – delays

```
<delay> ::= #<delay_value> | #(<delay_value>) | <delay2> | <delay3>
```

```
<delay2> ::= #(<delay_value>,<delay_value>)
```

```
<delay3> ::= #(<delay_value>,<delay_value>,<delay_value>)
```

```
<delay_value> ::= <unsigned_number> | <parameter_identifier> |  
                  <constant_mintypmax_expression>
```

```
<constant_mintypmax_expression> ::=  
    <constant_expression>:<constant_expression>:<constant_expression>
```

- **Delays**

```
<delay>
```

```
<rise_delay> <fall_delay>
```

```
<rise_delay> <fall_delay> <turnoff_delay>
```



## Advanced topics – more about nets – strength

```
<strength> ::= <charge_strength> | <drive_strength>
```

```
<charge_strength> ::= (small) | (medium) | (large)
```

```
<drive_strength> ::= (<zero_strength>,<one_strength>) |  
                    (<one_strength>,<zero_strength>)
```

```
<zero_strength> ::= supply0 | strong0 | pull0 | weak0 | highz0
```

```
<one_strength>  ::= supply1 | strong1 | pull1 | weak1 | highz1
```



## Advanced topics – more about gates

```
<gate_instantiation> ::=  
    <gate_type> [<drive_strength>] [<delay>] [<label>] (<terminals>);  
<gate_type> ::= and | nand | or | nor | xor | xnor |  
    buf | not | bufif0 | bufif1 | notif0 | notif1 |  
    nmos | pmos | rnmos | rpmos |  
    tran | rtran | tranif0 | tranif1 | rtranif0 | rtranif1 |  
    cmos | rcmos | pullup | pulldown  
<drive_strength> ::= (<zero_strength>, <one_strength>) |  
    <one_strength>, <zero_strength>
```

- and, nand, or, nor, xor, xnor - simple logic gates (output, input1, input2[,...])
- buf, not - simple buffers (output, input)
- bufif0, bufif1, notif0, notif1 - three-state drivers (output, data-input, control-input)
- nmos, pmos, rnmos, rpmos - transistors (output, data-input, control-input)
- tran, rtran - true bidirectional transmission gates (inout1, inout2)
- tranif0, tranif1, rtranif0, rtranif1 - true bidirectional transmission gates (io1, io2, control-input)
- cmos, rcmos - transmission gates (data-output, data-input, n-channel-control, p-channel-control)
- pullup, pulldown - drive strengths (logic-1/logic-0) (output)
- r<type> - relatively higher impedance when conducting



## Verilog vs. VHDL ?

or VHDL vs. Verilog ?

Feature	Verilog	VHDL
Type declaration	weak	strong
User defined types	- (macros)	++
User defined operators	--	++
Archives / libraries	- (simulator)	library & use
Reusability	- (include)	++ (package)
Pre-compilation	+ (limited macros)	- (alias)
Flexibility of constructions	@ operation level (predefined gates)	@ data level (attributes)
Usability & Synthesizability	RTL & lower level(s)	RTL & higher levels
Standardization	+ (simulator, now IEEE)	++ (IEEE)
Programming language	C (K&R)	Ada (OO Pascal)